

REV.	SPECIFICATION	ECN NO.	APPD.

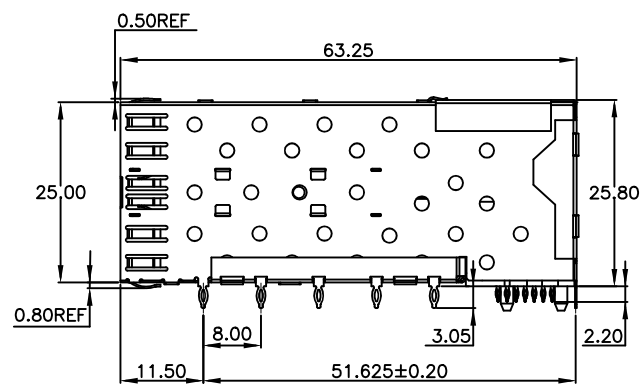

Material:
Housing: LCP,UL94V-0, Black.
Contact: Phosphor Bronze,Gold Plated on Contact Area and 150u" Tin Plated on solder tail over Nickel 50u".
Cage: Copper Alloy.
Light Pipe: PC,Clear.
Electrical Characteristics:
Operating Temperature: -40°C~+85°C
***RoHS Compliant**

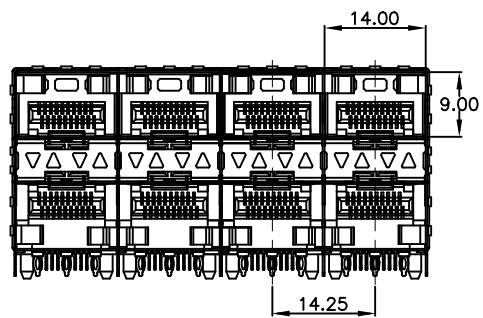
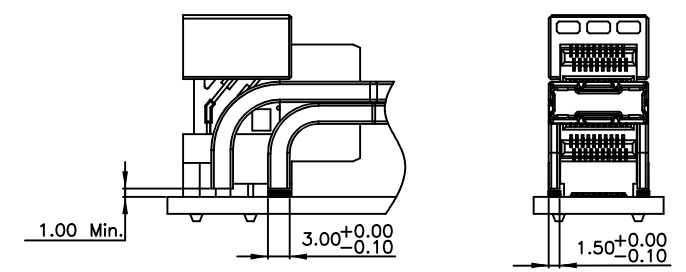
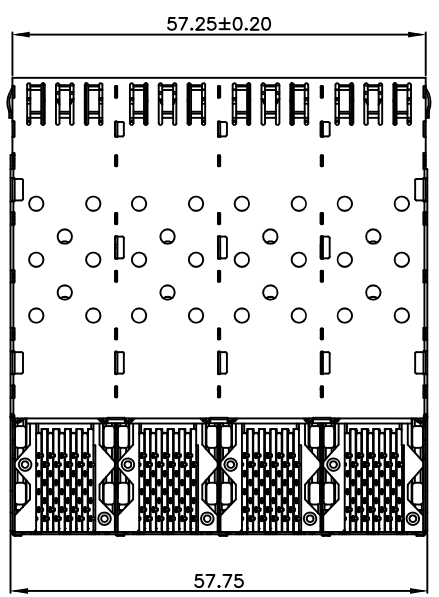

LED Clearance Requirements

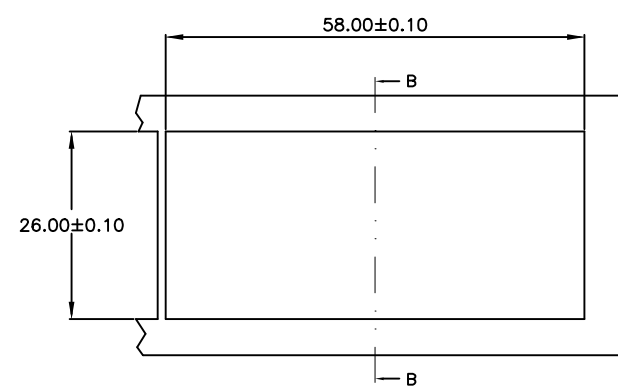

Recommended Panel Cutout and P.C. Board
Panel Position and Thickness 0.8-2.6

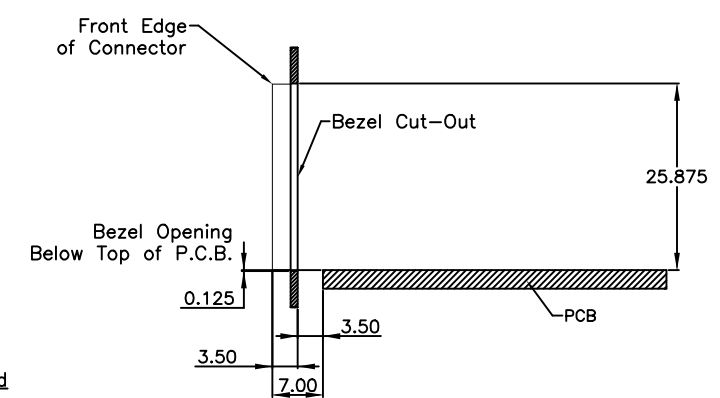

Section B-B

- 8952-A 2X4 C 15 P S x A
- Series
 - 2X4 Ports
 - C: Selective Gold Plated
 - 15: 15 μ"
 - 30: 30 μ"
 - A: Tray Package
 - 0: Without Light Pipes
 - 1: With Inner Light Pipes
 - 2: With Outer Light Pipes
 - 3: With Inner & Outer Light Pipes
 - S: Spring
 - P: Press Fit

Tolerances	Dwg. No.	8952D00012	
X. = ±0.50	Date	⊕ ⊖	
.X = ±0.30	Unit	mm	Scale 1/1
.XX = ±0.25	Drawn By	Sherry03/05'19	

Title: 8952 Series
SFP 2X4 Cage, R/A, Metal Shield
Press Fit Type With Connector
①665

OUPIIN
OUPIIN ELECTRONIC(KUNSHAN) CO., LTD.
P/N: 8952-A2X4C15PSxA

SHEET	1/3	Ver.No.	A3
--------------	-----	----------------	----

REV.	SPECIFICATION	ECN NO.	APPD.

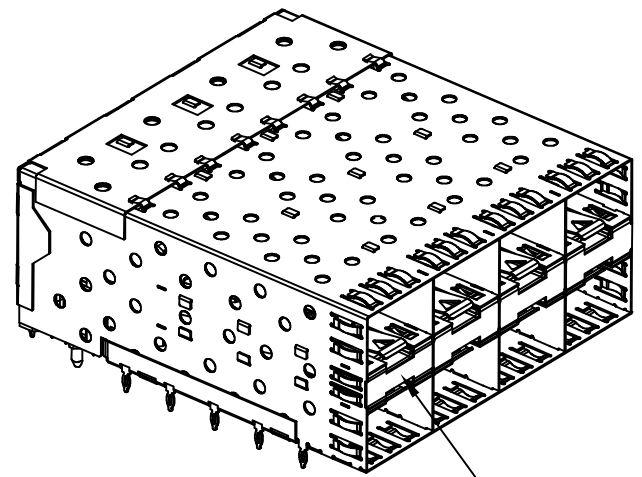

Without Light Pipe

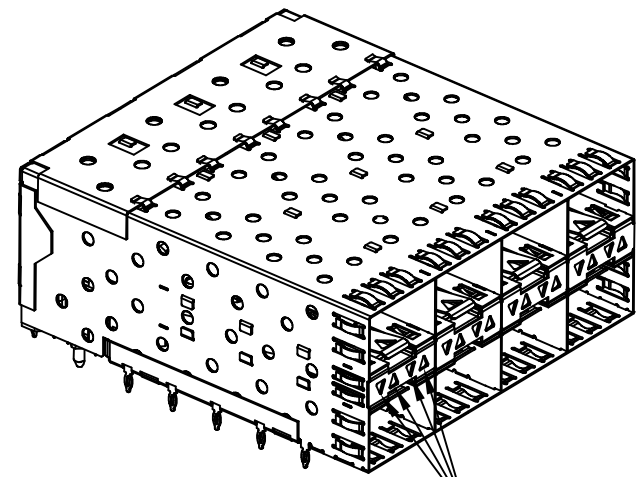

With Inner/Outer Light Pipe

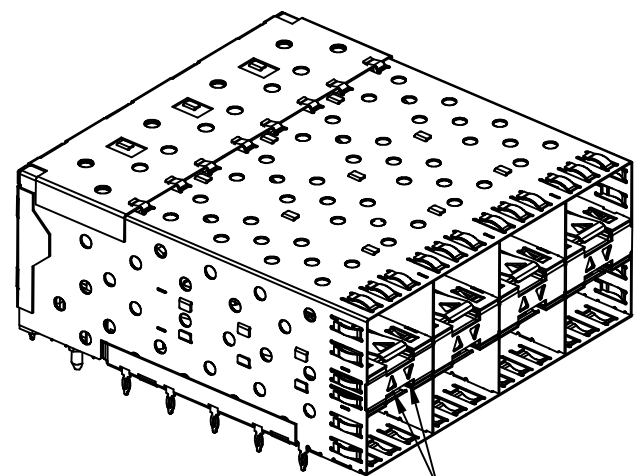

With Inner Light Pipe

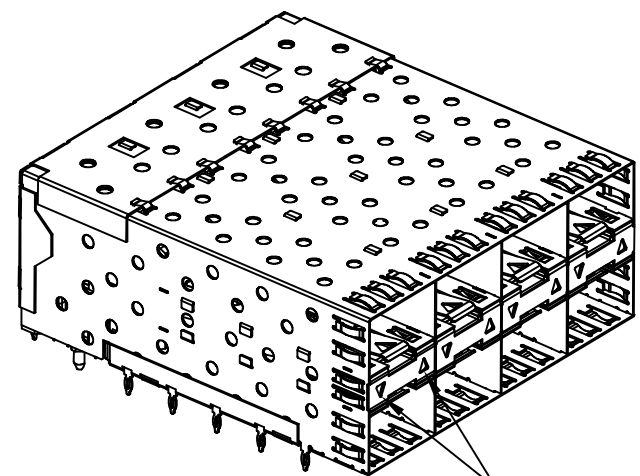

With Outer Light Pipe

Tolerances	Dwg. No.	8952D00012	
X. = ±0.50	Date	⊕ ◁	
.X = ±0.30	Unit	mm	Scale 1/1
.XX = ±0.25	Drawn By	Sherry03/05'19	

Title: 8952 Series
 SFP 2X4 Cage, R/A, Metal Shield
 Press Fit Type With Connector
 ⓐ665

OUPIN			
OUPIN ELECTRONIC(KUNSHAN) CO., LTD.			
P/N: 8952-A2X4C15PSxA			
SHEET	2/3	Ver.No.	A3

REV.	SPECIFICATION	ECN NO.	APPD.

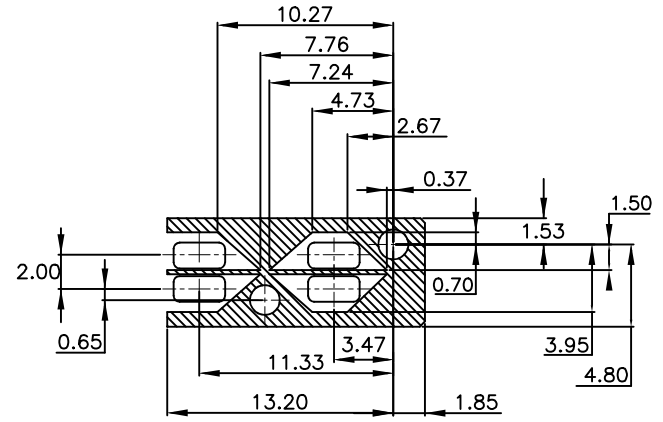
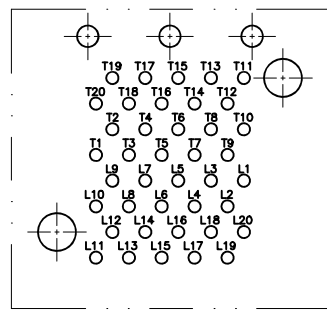
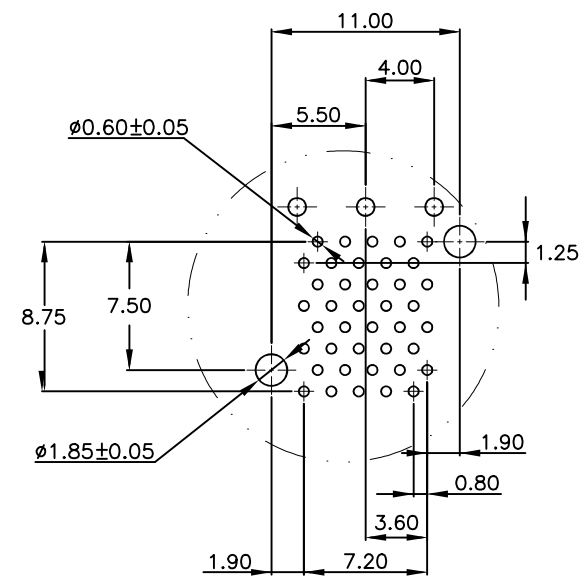
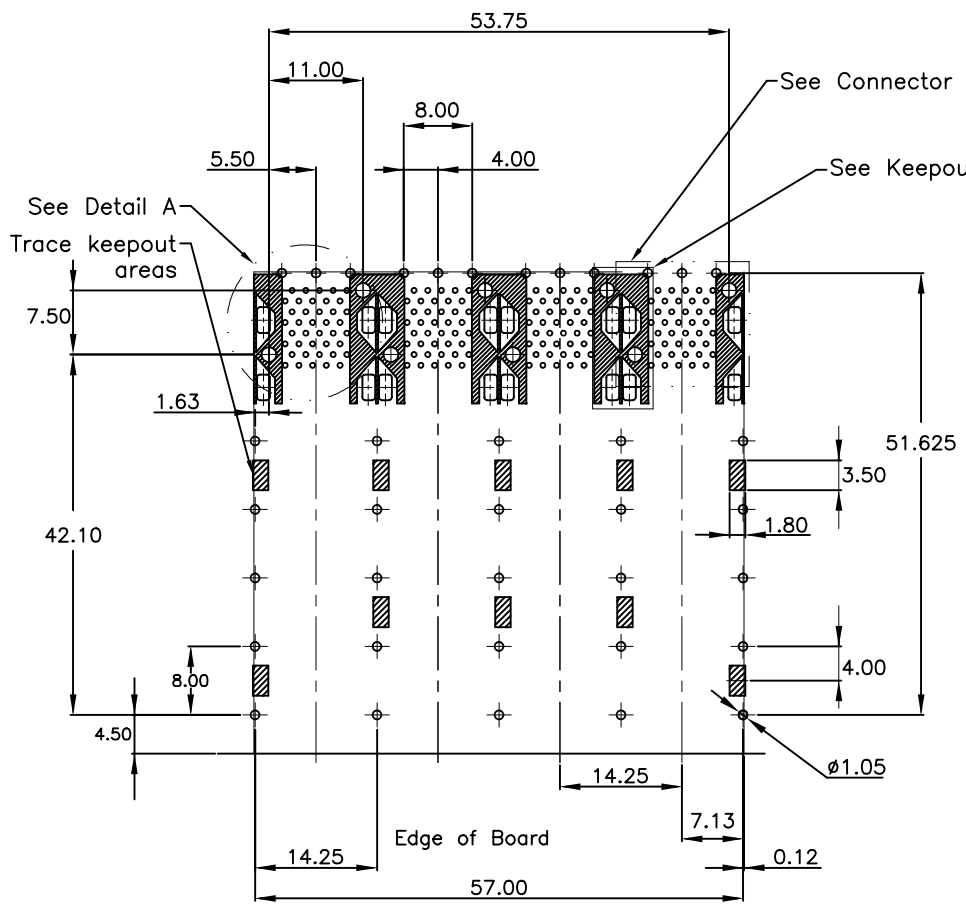

Recommended P.C. Board Layout
(Component Side)
P.C. Board Tolerance ± 0.05

Conncton Pinout Detail
Component Side of Board

Detail-Lightpipe Location and Other Zones
Scale 2:1

Tolerances	Dwg. No.	8952D00012		Title:	8952 Series		 OUPIN ELECTRONIC(KUNSHAN) CO., LTD. P/N: 8952-A2X4C15PSxA	
	X. = ± 0.50	Date	\oplus \triangleleft		SFP 2X4 Cage, R/A, Metal Shield			
	.X = ± 0.30	Unit	mm		Scale	1/1		
	.XX = ± 0.25	Drawn By	Sherry03/05'19		Press Fit Type With Connector			
				$\phi 665$	SHEET	3/3	Ver.No.	A3