

REV.	SPECIFICATION	ECN NO.	APPD.
X8			

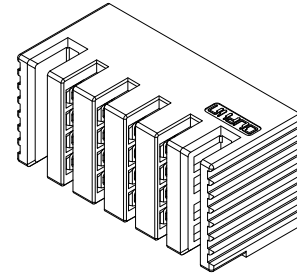
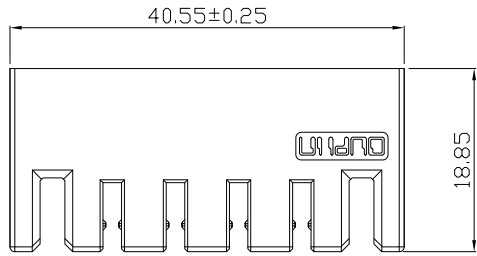

Material and Plating:

Housing: LCP, UL94V-0, Black.
 Contacts: High Conductivity Copper.
 Gold Plated on Contact Area and 80u" Min
 Tin Plated on Solder Tail over nickel 50u" Min .

Electrical Characteristics:

Current Rating: 100 AMP.
 Dielectric Withstanding Voltage: DC 1500V For 1 minute.
 Insulator Resistance: 1500MΩ min. at DC 500V.
 Contact Resistance: 0.70mΩ max.
 Operating Temperature: -55°C ~+125°C .

***RoHS Compliant**

Note:

1. IR Reflow & PIP

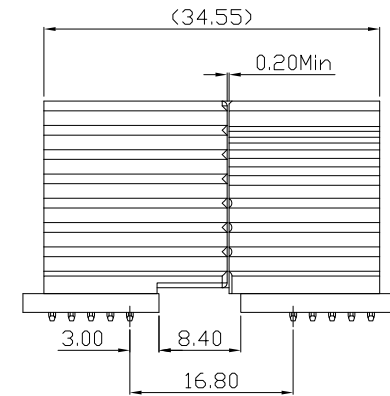
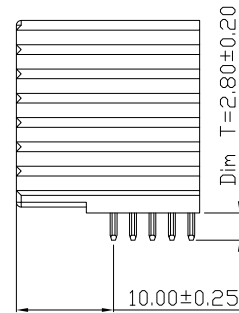
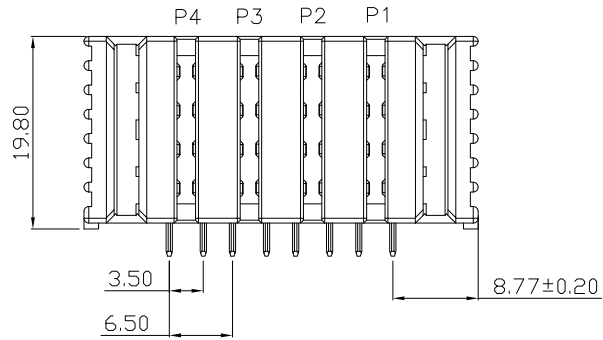

MATING BETWEEN MALE AND FEMALE

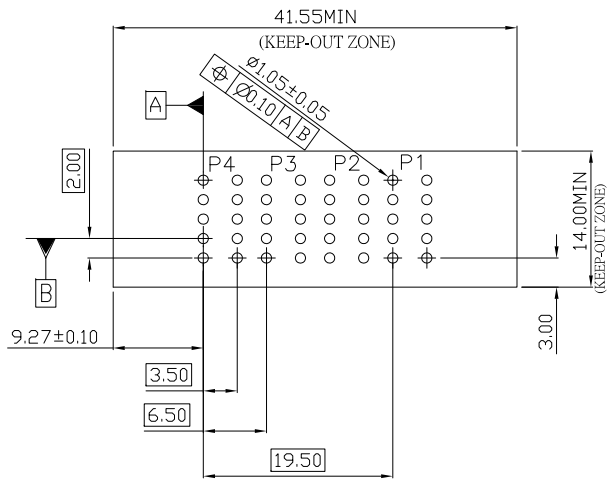

P.C.Board Layout(Top View)
(Tolerance:±0.05)

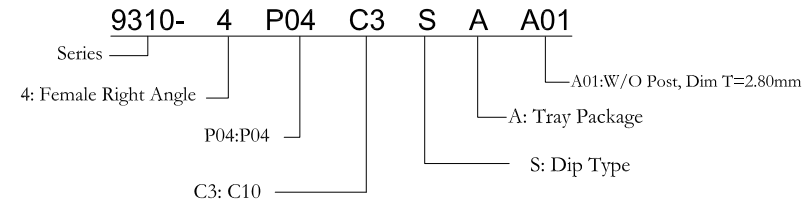

Tolerances	Dwg. No.	9310-DP04-001		Title:	
x = ±0.5	Projection	⊕ ↗		9310 Series	
.x = ±0.25	Unit	mm	Scale	Receptacle, Right Angle	
.xx = ±0.15	Drawn By	WP 01/13'24			

OUPIN			
OUPIN ELECTRONIC(KUNSHAN) CO., LTD.			
P/N: 9310-4P04C3SAA01			
SHEET	1/1	Ver. No.	X8