

REV.	SPECIFICATION	ECN NO.	APPD.
R4		ECN121231	

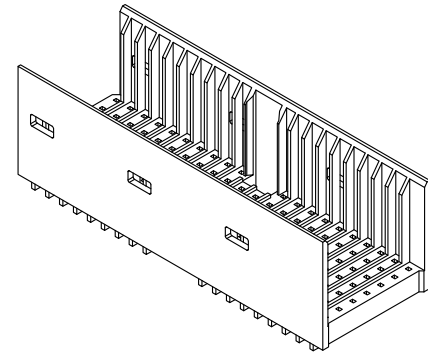
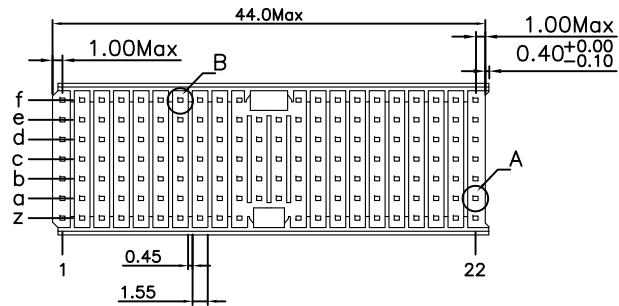

Material:

Housing: Thermoplastic Polyester Glass Filled UL94V-0

Electrical Characteristics:

Dielectric Withstanding Voltage: AC 750V For 1 minute.

Insulator Resistance: 10000MΩ min.at DC 500V.

Operating Temperature: -55°C ~ +125°C.

***RoHS Compliant**

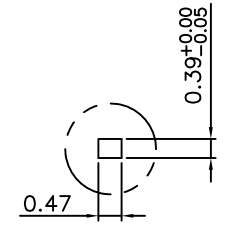
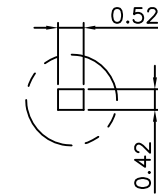
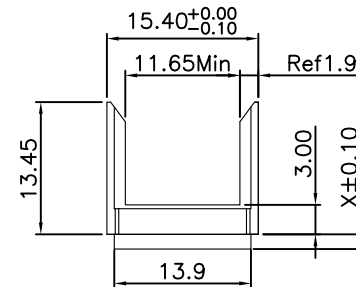
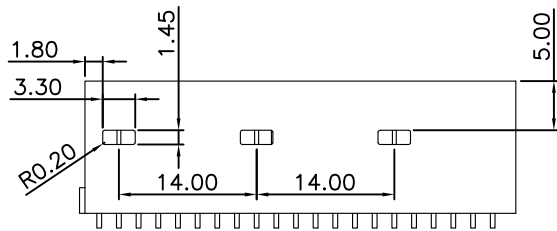

(4, 5, 6, 20, 21, 22P)

Detail B

Detail A

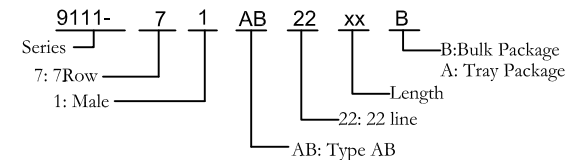
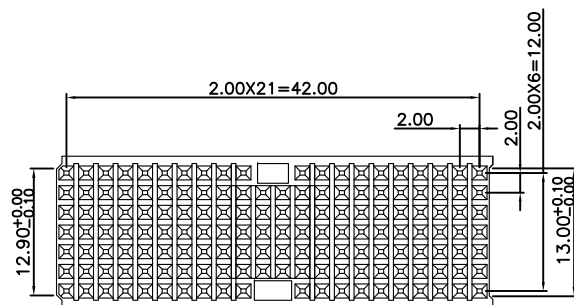

X	Length
00	0.00
01	0.90
02	1.10
03	1.30
04	1.50
05	1.70
06	1.90
07	2.20
08	3.00

Tolerances	Dwg. No.	9111D71176
x = ±0.5	Projection	
.x = ±0.25	Unit	mm
.xx = ±0.15	Scale	1:1
	Drawn By	CQ 12/14'12

Title: 9111 Series
2.00 Hard Metric
connectors shrouds
type AB Housing

OUPIN ELECTRONIC(KUNSHAN) CO., LTD.			
P/N: 9111-71AB22xxB			
SHEET	1/1	Ver.No.	R4