

REV.	SPECIFICATION	ECN NO.	APPD.

Material:

Housing: LCP,UL94V-0,Black.
 Contacts: Phosphor Bronze,Gold Plated on Contact Area and Gold Flash on Solder Tail over Nickel 50u".

Electrical Characteristics:

Current Rating: 3 AMP.
 Dielectric Withstanding Voltage: AC 600V.
 Insulator Resistance: 1000MΩ min.
 Contact Resistance: 20mΩ max.
 Operating Temperature: -40°C~+105°C .

***RoHS Compliant**

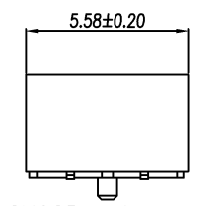
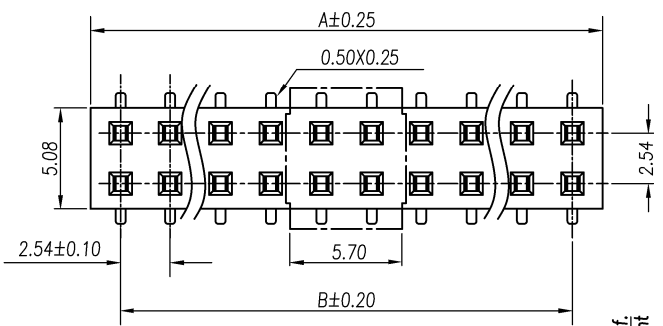

2X02P only one post

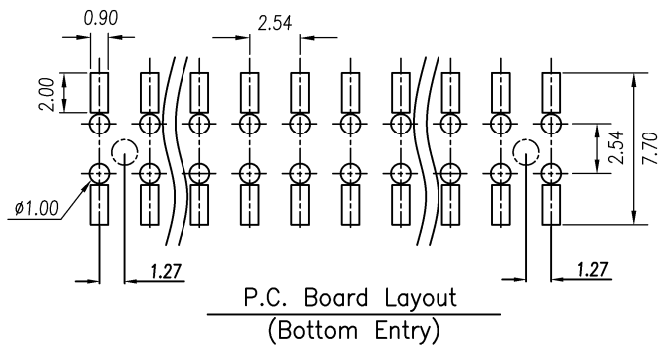
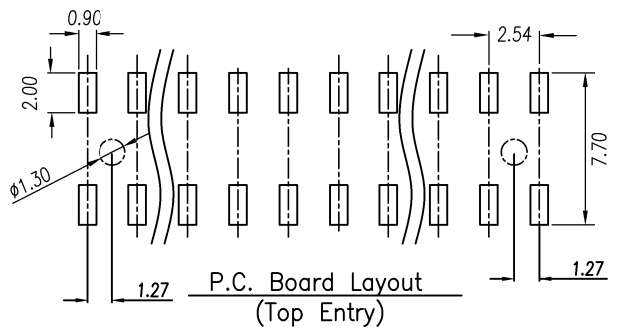
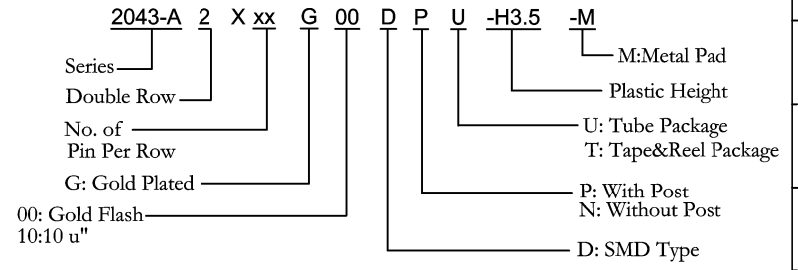
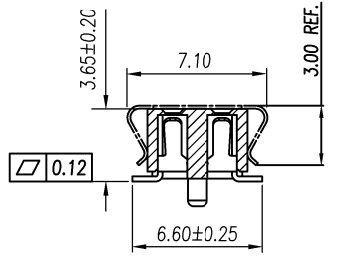
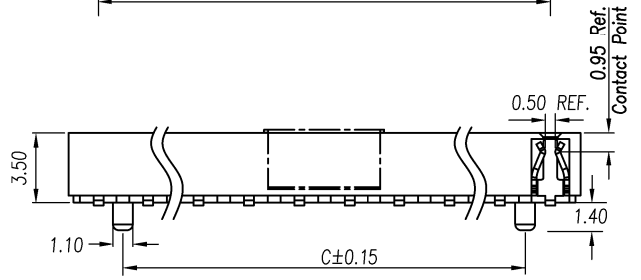

Positions	4 Thru 80
A	2.54 x No.of Positions/2+0.5
B	2.54 x No.of Positions/2 -2.54
C	2.54 x No.of Positions/2 -5.08

Tolerances	Dwg. No.	2043D02014	Title:		 DUPIN ELECTRONIC(KUNSHAN) CO., LTD. P/N: 2043-A2XxxG00DPU-H3.5-M SHEET 1/1 Ver.No. A7
x = ±0.3	Projection		2043-A Series		
.x = ±0.25	Unit	mm	Scale	1:1	
.xx = ±0.15	Drawn By	Jerry 10/08'19	P.C.B. Socket 2.54mm(0.100") SMD Type H: 3.5		