

REV.	SPECIFICATION	ECN NO.	APPD.

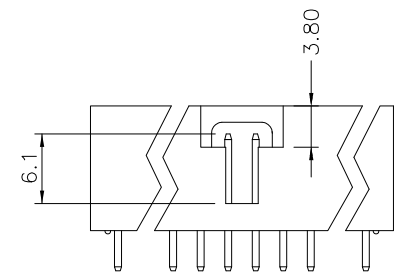
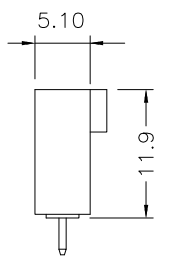
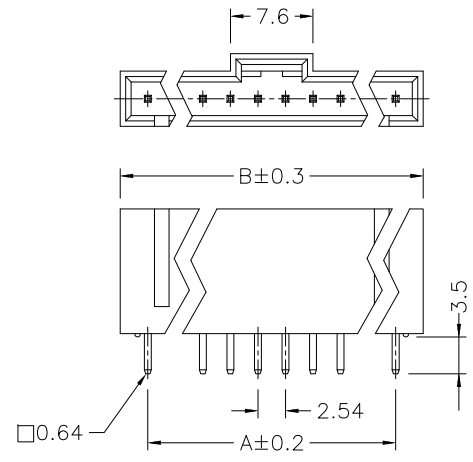

Material:

Housing: PBT,UL94V-0,Black.
 Contacts: Brass,0.64mm(0.25") Square Wire Pins,Gold Plated over Nickel 30u".

Electrical Characteristics:

Current Rating: 2.5 AMP.
 Voltage Rating: 250V AC/DC.
 Dielectric Withstanding Voltage: AC 600V for 1 minute.
 Insulator Resistance: 1000MΩ min.
 Contact Resistance: 20mΩ max.
 Operating Temperature: -25°C~+85°C.

***RoHS Compliant**

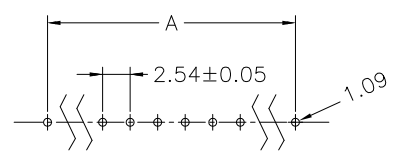
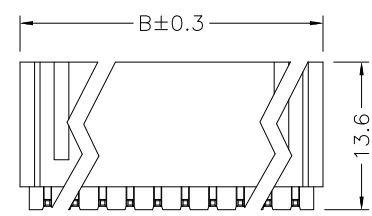
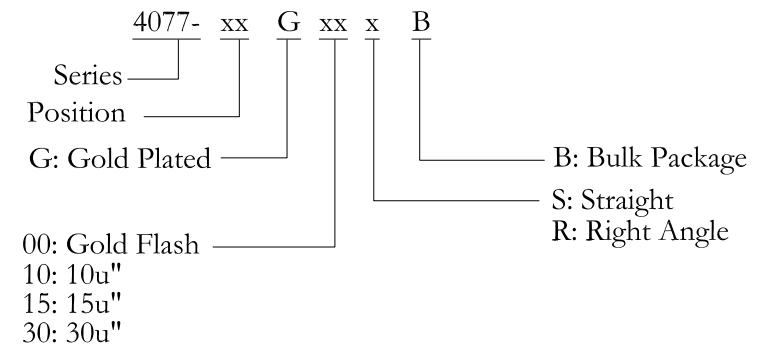
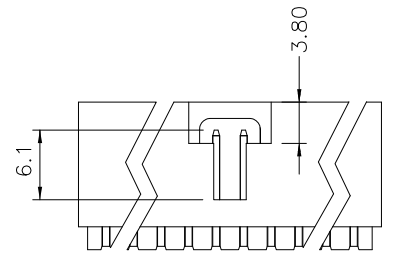
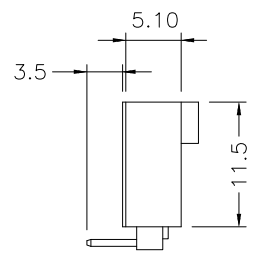
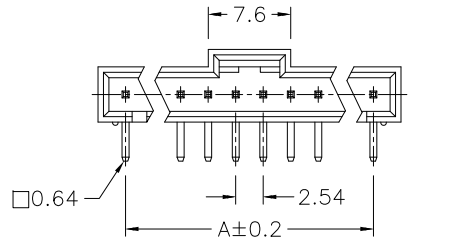

P.C. Board Layout

Positions	2 Thru 18
A	2.54 X No. of Positions - 2.54
B	2.54 X No. of Positions + 2.54

Tolerances	Dwg No.	4077D01002
x. = ±0.50	Projection	
.x = ±0.25	Unit	mm
.xx = ±0.15	Scale	1:N
	Drawn By	Ping 09/26'19

Title: 4077 Series
 2.54mm Wire to Board
 CD-Rom Header Straight & Right Angle Type
 704

OUPIIN ELECTRONIC(KUNSHAN) CO., LTD.			
P/N: 4077-xxGxxxB			
SHEET	1/1	Ver.No.	A8